

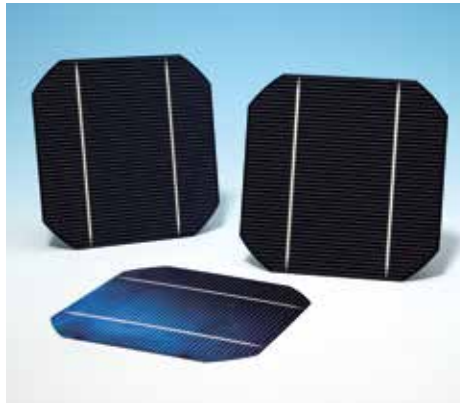

BOPP SD

Stainless Steel Screen Printing Meshes

In the world of technical screen printing, process challenges have increased steadily over recent years. Growing demand for the highest levels of precision in industries such as solar technology and electronics calls for the production of premium screens. The BOPP SD range offers a comprehensive selection of stainless steel meshes, designed specifically for screen printing applications. These materials have been developed over many years, working in close cooperation with leading screen manufacturers and users.



Mesh Production

We use only the best raw materials in the world for our fine meshes, drawn in-house to exacting wire diameters down to 15 microns.



These top quality wires are then woven in cleanroom conditions in a special air conditioned building, using state-of-the-art looms developed in house by our own specialists. For particularly challenging applications, these fine meshes can be cleaned and inspected electronically using purpose-designed equipment, also developed in-house. These exhaustive levels of quality assurance and process security guarantee a premium value end product and 100% reproducibility.



Mesh Properties

- Advanced levels of precision
- Extremely limited thickness tolerances
- Stable weave
- Above average flexural strength
- Clean, uniform surface area
- Excellent abrasion resistance
- No static loading
- Uniform appearance, no transition (mesh striping)
- Large open area
- Easy to fabricate

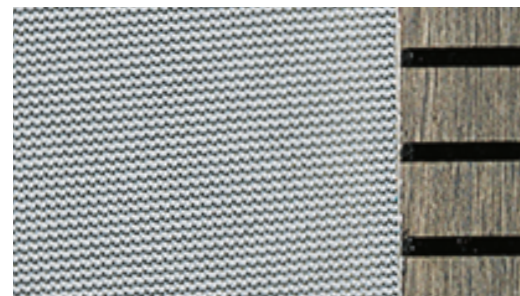

Results

- Optimum print quality
- Advanced load capacity and service life
- Controlled ink/paste deposit
- Minimal loss of tension during the tensioning and printing processes
- Excellent ink and paste flow
- Extended service life
- Maximum registration accuracy due to higher tensioning properties
- Improved off contact characteristics
- Advanced reproducibility at maximum printing speeds
- Fast stabilisation after tensioning
- Fast commissioning of screens



An ABC of screen printing meshes

■ Warp/Weft

The longitudinal direction of the mesh weave is known as the warp and the lateral direction is known as the weft. We work exclusively with stainless steel wires, which meet the highest specifications in terms of thickness tolerances, flexural strength and wire surface quality.



■ Mesh Opening w Wire Diameter d

The two most important variables of BOPP SD meshes are the mesh opening (w) and the wire diameter (d).

Example: BOPP SD 50/30

50 = Mesh opening w in microns
30 = Wire diameter d in microns

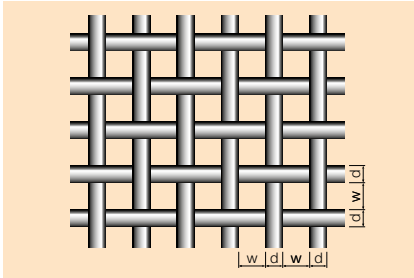

■ Mesh Fineness

The mesh fineness identifies the number of wires per imperial inch (mesh count):

$$\text{Mesh} = \frac{25.4 \text{ mm}}{(w/\text{mm} + d/\text{mm})}$$

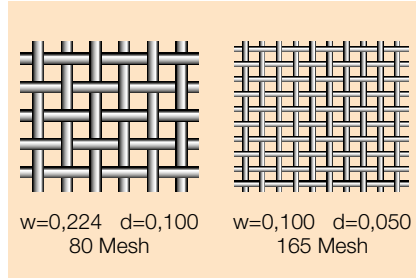

■ Open Area A_0

The open area describes the total open area in terms of mesh apertures across the entire surface of the mesh. The bigger the open area, the greater the colour throughput.

$$\text{Open area } A_0 = \left(\frac{w}{w + d} \right)^2 \times 100\%$$

Example: SD 50/30: 39%

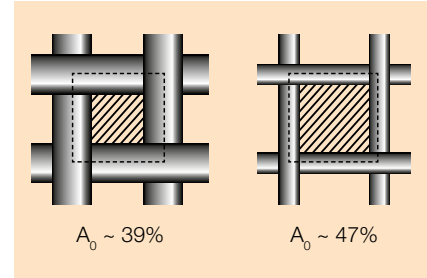

■ Mesh Thickness D

The mesh thickness is determined by the wire diameter and the weaving technique. The thickness measurement is taken with the mesh untensioned, using a gauge (measuring pressure 1.8N) on a rigid base. The tolerance values for unrolled mesh lie between +/- 2 to +/- 5 microns, dependent upon mesh type. Inside the roll, the tolerances are significantly higher.

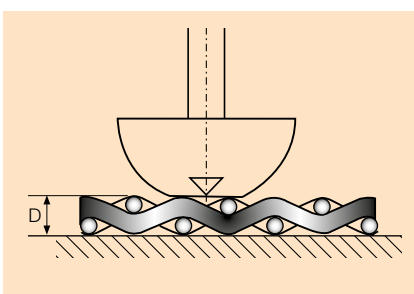

■ Theoretical ink deposit V_{th}

The theoretical ink deposit describes the volume of the open mesh calculated on the area of the substrate. In the event of insufficient colour lay down, a mesh with a high V_{th} should be used.

$$V_{th} (\text{cm}^3/\text{m}^2) = \left(\frac{w}{w + d} \right)^2 \times D \text{ or } A_0 \times D$$

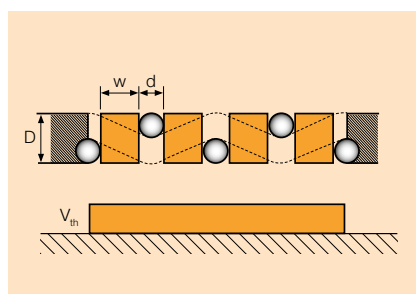

■ Tensioning

Correct tensioning values depend upon the application. The values given in our specifications are only recommendations. Please refer to data given in the section entitled "BOPP SD Mechanical Properties", Page 4.

Mesh Specifications

Raw materials

BOPP SD stainless steel meshes are manufactured using DIN 1.4301/AISI 304 and are available ex stock. Other materials such as DIN 1.4401/AISI 316 are available on request.

Mesh Dimensions

Standard widths:

1020 mm / 40"

1220 mm / 48"

1530 mm / 60" others available on request

Roll lengths:

30,50 m standard, longer rolls available on request

15,25 m for fine meshes, 500 mesh and finer

50,00 m for printing on glass

Mesh Types/Applications

Technical Data, see pages 12 to 14

Type	Application	Use
BOPP SD	Uncalendered/calendered to customer specification	Precision screen printing for electronics and solar cell technology
BOPP SD PLUS	Uncalendered/calendered to customer specification	Latest generation of screen printing meshes for high tensioning values. This improves the end result and registration accuracy.
BOPP SDS PLUS	Uncalendered/calendered to customer specification	Advanced rigidity and high levels of stability. High w/d ratio and/or very fine wire.
BOPP SD XD	Uncalendered	Screen printing requiring increased colour lay down, altered geometry, fewer contact points, mesh thickness ~ 2,5 x d
BOPP GP	No calendering	Cost effective screen printing meshes, exclusively for printing on glass and ceramics.

Mechanical Properties

In comparison with synthetics, stainless steel meshes exhibit the highest levels of flexural strength and the least percentage of elongation in terms of elastic yield point.

When printing on non-absorbent substrates, off contact distance should be used. The selected off contact distance must allow the screen directly behind the squeegee to detach from the substrate. Only then will the screen detach cleanly and completely from the colour, a prerequisite for a sharp print with even colour lay down.

The required off contact distance is determined by three factors:

- Mesh tension
- Rheology (ink viscosity)
- Squeegee speed

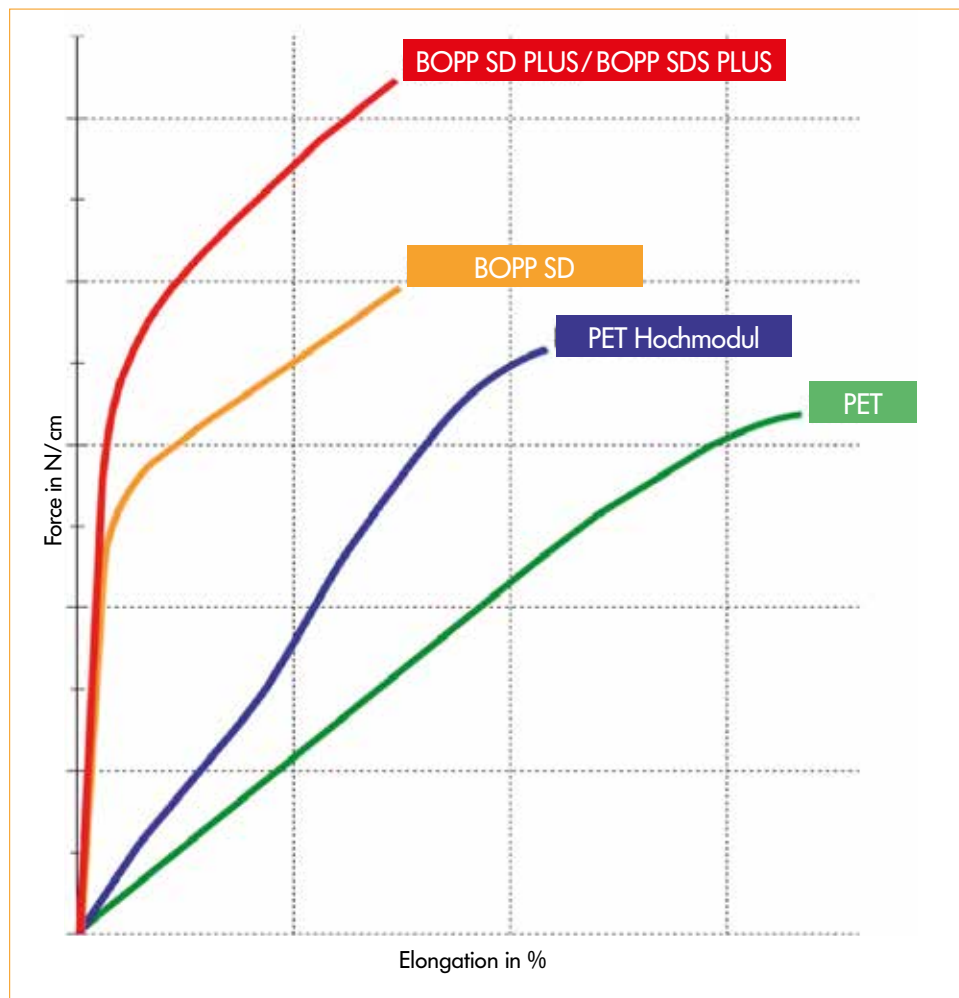

■ **Fact**

The higher the mesh tension, the lower the ink viscosity and the slower the squeegee speed, the smaller the off contact distance required.

When printing with off contact distance, the mesh deforms slightly, which has a negative effect on registration accuracy. The smaller the off contact distance, the less the mesh deforms and therefore the better the registration accuracy.

Note: Doubling the off contact distance will quadruple the image distortion.

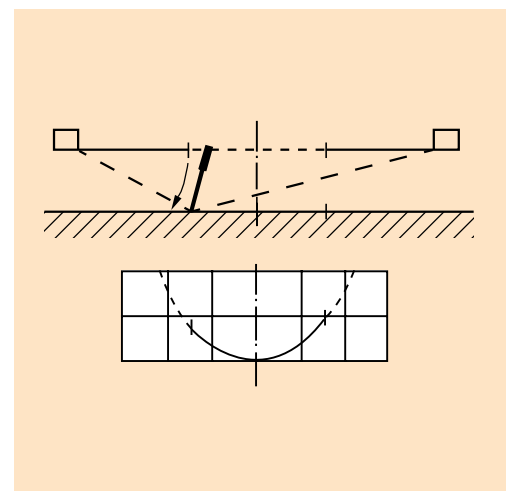
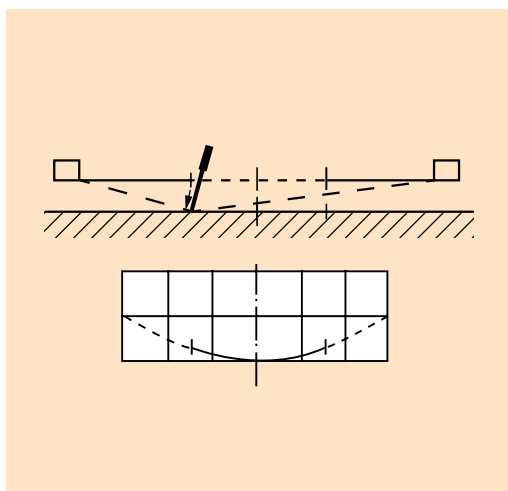

■ **Fact**

1. **Stainless steel meshes can be tensioned to higher values due to their greater flexural strength.**
2. **Higher screen tensioning values facilitate use of a smaller off contact distance.**
3. **The smaller the off contact distance, the better the registration accuracy.**

Recommended screen tension values for BOPP SD stainless steel meshes are dependent upon the print quality challenges.

Note: Selected BOPP SD meshes such as SD PLUS can be tensioned to values well beyond 35 N/cm. When tensioning to these levels, the stability of the frame should always be verified. Generally at this specification tension values of 30-35 N/cm should be adequate to achieve a perfect end result.

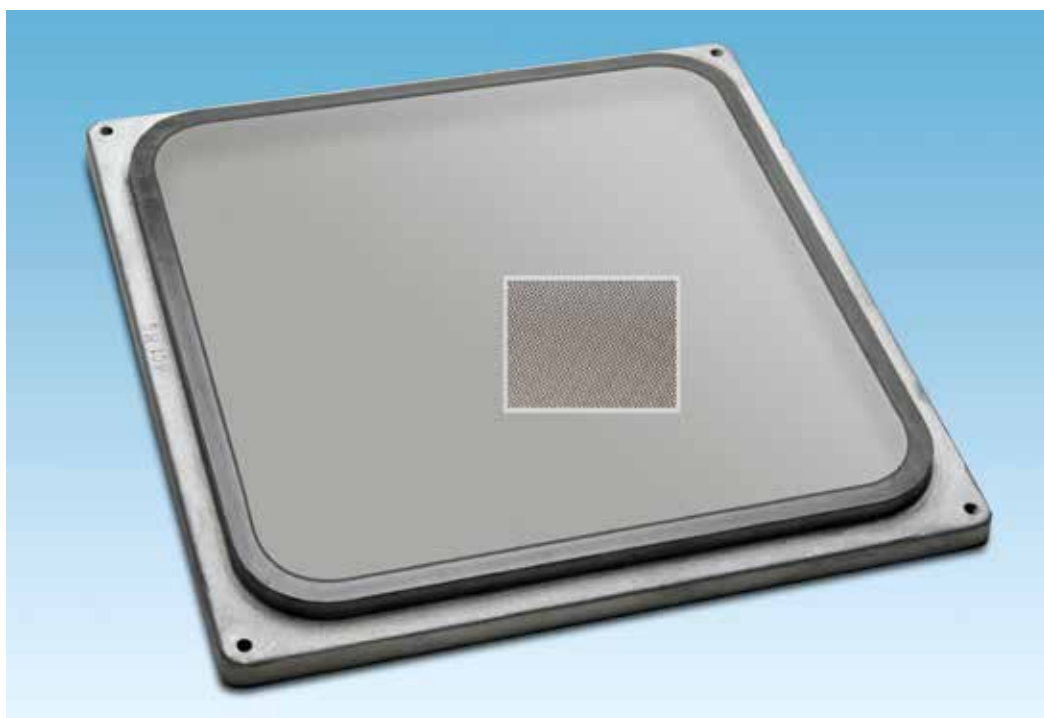

Recommendations

Our recommendations are based on many years of cooperation with customers, suppliers and partners from across the screen printing industry.

■ Frame Selection

BOPP SD stainless steel meshes are generally tensioned to higher values than synthetic meshes, and the continuous development and refining of mesh production perpetuates this trend. The frame must be capable of taking up and retaining these levels of tension. In order to achieve high value, reproducible printed results, the frame must exhibit high dimensional stability.

■ Fact

Metal frames must be used with BOPP SD stainless steel meshes.

We recommend cast aluminium or hollow aluminium profile options, where meshes are tensioned onto the frames.

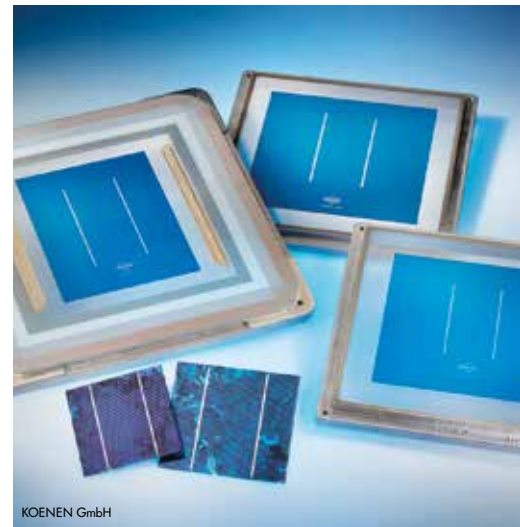

KOENEN GmbH

■ Frame Sizes

A frame which is too small in relation to the print image will lead to overloading of the mesh and to premature fatigue. In order to benefit from the full advantages of SD stainless steel meshes, attention should be paid to the geometric relationships detailed in this drawing.

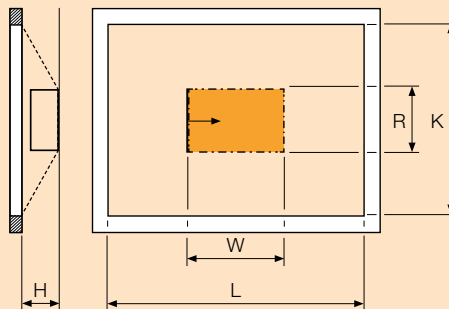

R = Squeegee width
W = Squeegee path
H = Snap Off distance

Screen Printing Frame:
K = ca. 3 x R
L = ca. 2 x W
H = ca. (0,002 – 0,005) x K*

*K or L, shorter Frame side

■ Tensioning

Not all tensioning equipment available on the market today is capable of achieving the above average tension values required by SD stainless steel meshes. The image on Page 7 shows a tensioning machine developed specifically for stainless steel meshes.

Correctly tensioned screens can achieve exceptionally long service lives. The following guidelines have proved their value in practice:

1. **Bring meshes up to the recommended tension value in stages. Raise tension in warp and weft directions alternately, always beginning with the warp direction.**
2. **During the tensioning process, check the tension values using a reliable measuring device such as a tensiometer or TEKTOMAT.**
3. **Leave the screen to rest for 15 – 30 min. then check and tension again accordingly.**



■ Aligning the Mesh

From a mechanical point of view, mounting frames at a 45° angle is the most stable option. However, for technical reasons or when printing very large formats this angle is not always optimal. Our recommendations:

1. **Where possible, mount meshes at an angle (22 to 45°).**
2. **If mounting the frames at angle is not possible, align the weft direction of the mesh to the squeegee.**



■ Preparing the screen

As a result of meticulous degreasing, the surface of the stainless steel wires provides an exceptional adhesive surface for all types of film and emulsion; no keying is necessary.

SD stainless steel meshes exhibit minimal levels of underexposure and can therefore be exposed to light without problems.

■ Printing

(off contact distance and squeegee pressure)
 Selecting the correct off contact distance is dependent upon a range of factors such as mesh tension, ink viscosity and squeegee speed, but also upon the print image itself. It is therefore impossible to give general recommendations for off contact distance and squeegee pressure. In principle, the following are valid:

1. **Always begin with the smallest possible off contact distance.**
2. **If the ink/paste does not come away cleanly from the screen, then increase the off contact distance in small steps.**
3. **Always work with the minimum squeegee pressure.**

■ Registration

If registration accuracy does not meet requirements despite minimum off contact distance, then increasing the size of the frame whilst retaining the same image size will significantly improve the end result.

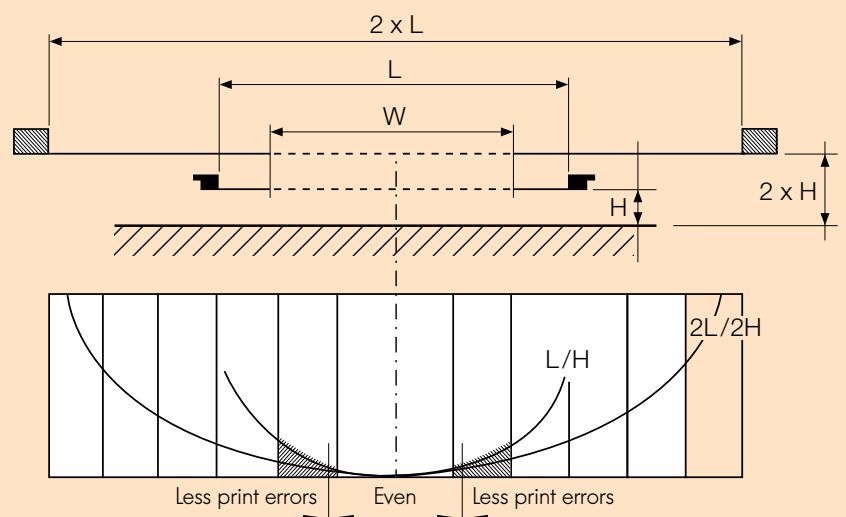

Services

■ Specialist Cleaning Processes

Although our fine meshes achieve above average levels of cleanliness due to our low abrasion production processes, some more challenging applications require special deep cleaning. Our purpose-designed mesh

cleaning installation operates using environmentally sound self contained systems, complete with an inspection and defect identification unit designed to pinpoint and electronically log the position of any defects. The cleaning installation is located in our cleanroom area.



■ Calendering

Rolling or calendaring improves fine meshes even further. Our calendaring plant was designed and built to our own specifications. Maximum calendaring force is 280 tonnes, and the equipment can handle mesh widths up to 1600mm. We can manage

any selected calendaring value, from soft calendaring (10% reduction in thickness) to heavy calendaring (30% reduction in thickness up to 45% for certain specifications), achieving tolerances of +/- 2 micron across the width and length of the roll.



■ Cutting

Cutting fine meshes manually was always a demanding process in terms of accuracy of measurement, the quality of the cut edge and the overall integrity of the cut piece. Today, this work is carried out by our computer controlled automatic cutting machine. On a work surface measuring

1800 x 1200mm, we can cut automatically to almost any pattern without touching by human hand. One significant advantage of this is that cut pieces are packed without handling. The equipment is designed to cut wires up to 0.1mm in diameter and mesh thicknesses up to 0.2mm.

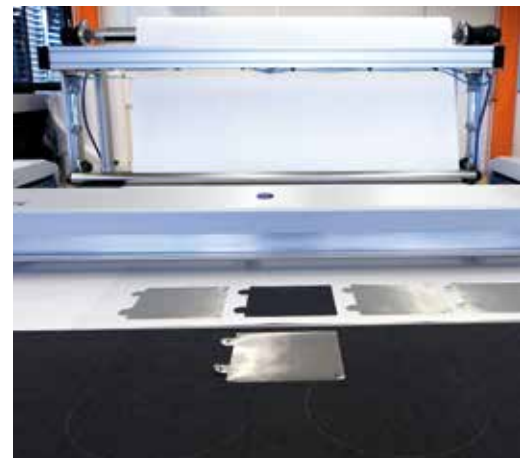

■ Bespoke Meshes

Our extensive portfolio of screen printing meshes enables us to respond to more than 95% of standard market requirements. We

are also pleased to produce mesh to individual specifications on request, where quantities ordered facilitate cost effective production levels.

Main Field of Application: Solar Cell Technology

The shortage of traditional energy sources and the corresponding increase in levels of environmental awareness have lent considerable impact to the importance of alternative energy sources and the continued technical development of these sources. One significant area in this growing market is photovoltaics, a sector which is demonstrating consistent growth thanks to sustained increases in efficiency and ever-reducing production costs.

One of vital elements of the production process is the plating of the wafer. This is carried out using specialist screen printing processes, generally achieved with high precision stainless steel meshes.

■ Mesh Properties

- Mesh types developed specifically for individual applications
- Exact control of thickness achieved using precision calendering for minimum thickness tolerances
- Extremely high tension values
- Excellent resistance to abrasion
- Resistant to physical loading
- Extremely high regularity of aperture size
- Even, clean surface area
- 100% reproducibility

■ Mesh Recommendations

Mesh	Aperture size	Wire Diameter-Ø	Open Area	Front (VS) / Back (RS)
400	45 µm	18 µm	51%	VS
350	56 µm	16 µm	60%	VS
325	50 µm	28 µm	41%	RS/VS
325	50 µm	30 µm	39%	RS
325	53 µm	24 µm	47%	VS
325	60 µm	18 µm	59%	VS
325	62 µm	16 µm	63%	VS
320	56 µm	22 µm	52%	VS
300	65 µm	20 µm	58%	VS
280	59 µm	32 µm	42%	RS
280	67 µm	25 µm	53%	VS
275	72 µm	20 µm	61%	VS
250	63 µm	36 µm	41%	RS
250	63 µm	40 µm	37%	RS
250	71 µm	30 µm	49%	RS
230	75 µm	36 µm	46%	RS
200	90 µm	40 µm	48%	RS

11.2017

■ Services

- Consultancy services to optimise mesh specification choice
- Calendering to customer requirements
- Specialist mesh cleaning processes for challenging applications
- Highly precise, defect free mesh cutting to individual requirements, preserving the mesh, with fully automated cutting of one-offs or production runs, advanced levels of productivity
- Advice and technical support from our specialists

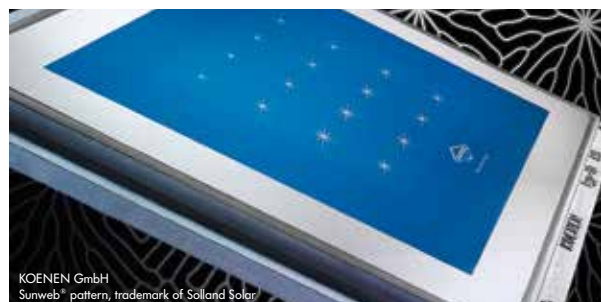

■ Results

- Optimum print quality
- Maximum registration accuracy thanks to higher tensioning properties
- Controlled ink/paste deposit
- Improved off contact distances
- Higher levels of print reproducibility and maximum printing speed
- Fast stabilisation after tensioning
- Minimal fall off in tension during the tensioning and printing processes
- Faster commissioning of screen printing processes
- Excellent ink/paste flow



Main Field of Application: Technical Screen Printing, Electronics

Without highly developed technology and electronics, life in today's information-based society would not be possible. In our daily lives as well as in industry and commerce, machines take on many tasks which we would be unable to manage without technical support. In these fast-moving times, we have become accustomed to using high tech products, without being aware that real technical achievements are hidden in these practical devices.

A significant proportion of these products have been made possible by highly developed screen printing processes. In the majority of cases, stainless steel meshes of the highest quality are used for these processes. BOPP SD meshes have been developed specifically to meet these challenges, and continuously optimised over the years.

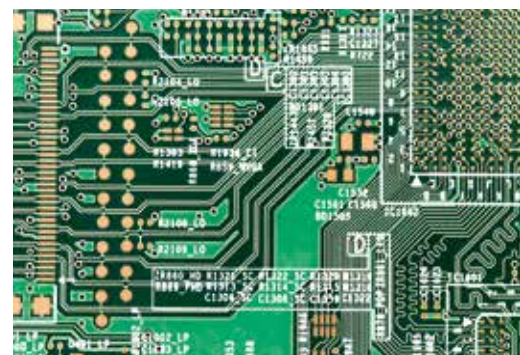

Key industry sectors

- Automotive and aeronautical industries
- Semiconductor industry
- Telecommunications
- Industrial electronics
- Consumer electronics



Typical Applications

- Touch Panels TP
- Organic light emitting diodes, OLED
- Liquid crystal displays, LCD
- Plasma displays, PDP
- Flat screen technology, FED
- Electronic paper, E-Paper
- MLCC components, ceramic capacitors
- LTCC circuitry, Low Temperature Cofired Ceramics
- Chip Production
- All kinds of semiconductors
- Printed circuit boards (PCBs), single and double sided

- Flexible PCB tracks, FPC, single and double sided
- Thick film circuitry
- Radio traffic and networks, RFID
- Solder paste, SMT
- Membrane switches
- Scales



Example: Challenges when producing printed circuitry

- Optimum registration accuracy
- Thinnest layers
- Largest PCB track thicknesses
- Biggest ink volumes
- Highest resolution
- Guaranteed reproducibility

Mesh Recommendations

Conductor			
< 300µm	SD PLUS	59/32	(280 mesh)
< 200µm	SD PLUS	50/30	(325 mesh)
< 100µm	SD PLUS	53/24	(325 mesh)
< 100µm	SD PLUS	40/23	(400 mesh)
< 80µm	SDS PLUS	60/18	(400 mesh)
< 80µm	SDS PLUS	56/22	(325 mesh)
< 80µm	SDS PLUS	65/20	(300 mesh)
< 60µm	SD PLUS	45/18	(400 mesh)
< 50µm	SD PLUS	32/18	(500 mesh)
< 40µm	SD PLUS	35/16	(500 mesh)
< 30µm	SDS PLUS	25/15	(635 mesh)

Solder Paste	SD	300/65	(70 mesh)	to	SD	245/65	(82 mesh)
Solder Resist	SD	224/100	(80 mesh)	to	SD	140/65	(120 mesh)
Resistance	SD	95/45	(180 mesh)	to	SD	56/36	(270 mesh)
Dielectric	SD	56/32	(300 mesh)	to	SD	40/25	(400 mesh)



Main Field of Application: Printing on Glass and Ceramics

Modern glass and ceramics printing places significant demands on the printing process. Many of these products are classified as luxury goods, with correspondingly high quality standards in terms of decoration, outline and coloration, combined with low accepted tolerance values. Very specific requirements have become the norm in this sector, such as pastes loaded with gold or individual shapes which present technically difficult print challenges. In addition, the image must also exhibit mechanical, thermal and chemical resistance.

Developed with practical relevance in mind, the BOPP GP range offers a selection of stainless steel meshes designed specifically to meet the needs of today's glass and ceramics printing industries. BOPP GP meshes are particularly suitable for printing processes using thermo-plastic colours.

■ Properties

- Advanced aperture regularity
- Strict thickness tolerances
- High levels of stability
- Large open area
- Uniform appearance, no transitions (mesh stripes)
- Above average flexural strength
- Excellent resistance to abrasion
- Uniform wire surface
- No static loading
- Easy to fabricate



■ Results

- Maximum registration accuracy
- High resolution
- Controlled ink/paste deposit
- Long service life



Technical Data – BOPP SD

Description	Aperture Size Rating w µm	Wire Rating d µm	Mesh per Inch	Mesh per cm	Open Area A ₀ %	Thickness µm	Theoretical Ink Deposit V _{th} cm ³ /m ²	Thickness calendered µm	Theoretical Ink Deposit V _{th} calendered cm ³ /m ²	Recommended Screen Tension N/cm
Standard grades										
224/100	224	100	80	31	48	215 ± 5	103	172	82	~ 40
160/75	160	75	105	43	46	162 ± 4	75	130	60	
140/65	140	65	120	49	47	135 ± 5	65	112	52	
125/65	125	65	135	53	43	140 ± 4	61	112	49	
118/56	118	56	145	57	46	120 ± 3	55	96	44	
100/50	100	50	165	67	44	110 ± 2	49	88	39	~ 35
95/45	95	45	180	71	46	102 ± 2	47	82	38	
90/40	90	40	200	77	48	90 ± 2	43	72	34	
75/36	75	36	230	90	46	80 ± 2	37	64	30	
63/36	63	36	250	101	40	80 ± 2	32	64	26	
59/32	59	32	280	110	42	68 ± 2	29	54	23	~ 30
56/36	56	36	270	109	37	80 ± 2	30	64	24	
56/32	56	32	300	114	40	68 ± 2	28	54	22	
50/30	50	30	325	125	39	62 ± 2	24	50	19	
50/28	50	28	325	128	41	58 ± 2	24	46	19	
40/28	40	28	370	147	35	58 ± 2	20	46	16	~ 30
40/25	40	25	400	154	38	51 ± 2	19	41	15	
40/23	40	23	400	159	40	48 ± 2	19	38	15	

11.2017

Heavy grades										
100/65	100	65	150	61	37	140 ± 4	51	112	41	~ 40
80/50	80	50	200	77	38	110 ± 2	42	88	34	
63/40	63	40	250	97	37	90 ± 2	34	72	27	
56/40	56	40	270	104	34	88 ± 2	30	70	24	
42/36	42	36	325 K	128	29	76 ± 2	22	61	18	
36/28	36	28	400 K	156	32	60 ± 2	19	48	15	~ 35
32/25	32	25	450 K	175	32	54 ± 2	17	43	14	
25/25	25	25	510 K	200	25	54 ± 2	14	43	11	

K = Twilled

11.2017

Ultra thin grades										
300/65	300	65	70	27	68	140 ± 3	95	112	76	~ 30
245/65	245	65	82	32	62	140 ± 4	87	112	70	
265/50	265	50	80	32	71	110 ± 2	78	88	62	~ 25
90/36	90	36	200	79	51	80 ± 2	41	64	33	

11.2017

Other specifications available on request.

Tensioning values are established using a tensile testing machine in line with ISO 4003 standards. Experience shows that two dimensional tensioning values on the tensioning table are higher. For exact values, please refer to our data sheet.

Technical Data – BOPP SD PLUS

Description	Aperture Size Rating	Wire Rating	Mesh	Mesh	Open Area A ₀	Thickness	Theoretical Ink Deposit V _h	Thickness calendered	Theoretical Ink Deposit V _h calendered	Recommended Screen Tension
	w μm	d μm	per Inch	per cm						
SD PLUS 98/30	98	30	200	78	59	60 ± 2	35	48	28	~ 50
SD PLUS 90/40	90	40	200	77	48	80 ± 2	38	64	31	
SD PLUS 90/36	90	36	200	79	51	72 ± 2	37	58	30	
SD PLUS 80/30	80	30	230	91	53	60 ± 2	32	48	26	
SD PLUS 75/36	75	36	230	90	46	72 ± 2	33	58	27	~ 45
SD PLUS 71/30	71	30	250	99	49	60 ± 2	30	48	24	
SD PLUS 67/25	67	25	280	109	53	50 ± 2	27	40	21	
SD PLUS 63/36	63	36	250	101	40	72 ± 2	29	58	24	
SD PLUS 59/32	59	32	280	110	42	64 ± 2	27	52	22	
SD PLUS 56/32	56	32	300	114	40	64 ± 2	26	52	21	
SD PLUS 53/24	53	24	325	130	47	48 ± 2	23	38	18	~ 40
SD PLUS 50/30	50	30	325	125	39	60 ± 2	23	48	19	
SD PLUS 50/28	50	28	325	128	41	56 ± 2	23	45	19	
SD PLUS 45/18	45	18	400	159	51	36 ± 2	17	29	16	
SD PLUS 40/25	40	25	400	154	38	50 ± 2	19	40	15	
SD PLUS 40/23	40	23	400	159	40	46 ± 2	19	37	15	
SD PLUS 35/16	35	16	500	196	47	32 ± 2	15	26	12	~ 35
SD PLUS 32/18	32	18	500	200	41	36 ± 2	15	29	12	

11.2017

Other specifications available on request.

Technical Data – BOPP SDS PLUS

Description	Aperture Size Rating	Wire Rating	Mesh	Mesh	Open Area A ₀	Thickness	Theoretical Ink Deposit V _h	Thickness calendered	Theoretical Ink Deposit V _h calendered	Recommended Screen Tension
	w μm	d μm	per Inch	per cm						
SDS PLUS 85/25	85	25	230	91	60	50 ± 2	30	40	24	~ 30
SDS PLUS 72/20	72	20	275	109	61	40 ± 2	25	32	20	
SDS PLUS 65/20	65	20	300	118	60	40 ± 2	23	32	19	
SDS PLUS 62/16	62	16	325	128	63	32 ± 2	20	26	16	
SDS PLUS 60/18	60	18	325	128	59	36 ± 2	21	29	17	
SDS PLUS 56/22	56	22	320	128	52	44 ± 2	23	35	18	
SDS PLUS 56/16	56	16	350	139	60	32 ± 2	19	26	16	
SDS PLUS 48/16	48	16	400	156	56	32 ± 2	18	26	15	
SDS PLUS 40/16	40	16	450	178	51	32 ± 2	16	26	13	
SDS PLUS 25/15	25	15	635	250	39	30 ± 2	12	24	9	

11.2017

Other specifications available on request.

Technical Data – BOPP SD XD

Description	Aperture Size	Wire Dia. d	Mesh	Mesh	Open Area A ₀	Thickness	Theoretical Ink Deposit V _h	Recommended Screen Tension
	w μm	μm	per Inch	per cm				
SD XD 50/30	50	30	325	125	39	78 ± 3	30	~ 35

11.2017

Other specifications available on request.

Technical Data – BOPP GP

Description	Aperture Size w µm	Wire Dia. d µm	Mesh per Inch	Mesh per cm	Open Area A ₀ %	Thickness µm	Theoretical Ink Deposit V _{th} cm ³ /m ²	Recommended Screen Tension N/cm
100/50	100	50	165	67	44	105 ± 7	47	~ 35
95/45	95	45	180	71	46	95 ± 7	44	
90/40	90	40	200	77	48	85 ± 7	41	
75/36	75	36	230	90	46	75 ± 6	34	
63/40	63	40	250	97	37	90 ± 6	34	
56/36	56	36	270	109	37	80 ± 6	30	
56/32	56	32	300	114	41	68 ± 6	28	~ 30
50/30	50	30	325	125	39	62 ± 4	24	
42/25	42	25	380	150	39	51 ± 4	20	
40/25	40	25	400	154	38	51 ± 4	19	

11/2017

Tensioning values are established using a tensile testing machine in line with ISO 4003 standards. Experience shows that two dimensional tensioning values on the tensioning table are higher. For exact values, please refer to our data sheet.

General Data for all Meshes

Material	DIN 1.4301 / AISI 304
Widths	1020 mm / 40", 1220 mm / 48", 1530 mm / 60", some specifications up to 2800 mm possible
Roll lengths	30 metres as standard, longer rolls available on request
Specifications	The information gives typical values rather than laboratory values. Production related discrepancies may occur, as well as technical changes due to further developments.
Sample order information	BOPP SD PLUS, w/mm, d/mm, width/mm, length/m
Mesh certification	A mesh thickness certificate will be supplied for each roll.
Special designs	To meet special requirements and where sufficient volume is requested, bespoke meshes can be manufactured. Please contact us for further information on this.

Troubleshooting Plan

Problem	Cause	Solution
1. Screen sticking, dragging:	• Insufficient tensioning >>>	• Tension to recommended value
	• Loss of tension after bonding >>>	• Check tension meter • Select stronger frames • Check adhesive • Check drying temperature • Extend tensioning time
	• Off contact distance too small >>>	• Increase in 0.2mm steps
	• Emulsion or film sticking >>>	• Check resistance
	• Flood squeegee not set properly >>>	• Adjust distance and speed
2. Inaccurate registration, registration not correct	• Screen not positioned accurately enough above substrate >>>	• Position more accurately
	• Off contact distance too great >>>	• Reduce off contact distance
	• Frame too small >>>	• Select larger frame
	• Insufficient screen tension >>>	• Check tension value of screen
	• Squeegee pressure too high >>>	• Check squeegee pressure
3. Incorrect ink/ paste deposit thickness	• Mesh too fine/ too coarse >>>	• Select a mesh with a correspondingly higher/lower V_{th}
	• Coating or film too thin/ too thick >>>	• Coat more thinly/ thickly
	• Squeegee too soft/ too hard >>>	• Correct hardness of squeegee (shore value)
	• Squeegee speed too high/ too low >>>	• Check squeegee speed
4. Image not fully displayed	• Squeegee/ screen/ substrate are not in parallel >>>	• Align, check squeegee angle
	• Ink viscosity too high >>>	• Check, thin ink
	• Screen too thick, ink/ paste stays in screen >>>	• Check, change screen
	• Colour dries out in the screen >>>	• Wash off, change screen
	• Mesh too fine for application >>>	• Select a coarser mesh
	• Insufficient squeegee pressure >>>	• Increase carefully, monitor registration
	• Squeegee movement not correct >>>	• Check distance and speed
5. Image reproduction, marginal sharpness	• Open area of mesh too small >>>	• Select a mesh with a larger open area
	• Mesh too coarse for application >>>	• Select finer mesh with higher mesh count
	• Off contact distance too great >>>	• Select smaller off contact distance
	• Poor mesh traverse >>>	• Check coating or film, develop further
	• Relationship of mesh angle to print line unfavourable >>>	• Check conductor design
	• Substrate too rough >>>	• Check roughness, mill angles

The above-mentioned problems and their causes should not be considered in isolation; in most cases each will have an effect on another. It is therefore vital when testing to optimise processes that parameters are changed and the effects of the change established one by one.

Head office in Zurich



■ SWITZERLAND

G. BOPP + CO. AG

Bachmannweg 21
CH-8046 Zurich
Phone +41 (0)44 377 66 66
E-mail info@bopp.ch
www.bopp.com

G. BOPP + CO. AG

Mühltoibel
CH-9427 Wolfhalden
Phone +41 (0)71 888 60 66
E-mail info@boppwh.ch

Filinox AG

Mühltoibel
CH-9427 Wolfhalden
Phone +41 (0)71 888 60 22
E-mail info@filinox.ch

■ GERMANY

Spörl KG

Staudenweg 13
D-72517 Sigmaringendorf
Phone +49 (0) 7571 7393-0
E-mail post@spoerl.de
www.spoerl.de

■ ENGLAND

G. BOPP & CO. LTD.

Grange Close
Clover Nook Industrial Park
Somercotes, Derbyshire DE 55 4QT
Phone +44 (0) 1773 521 266
E-mail info@gbopp.com
www.boppmesh.com

■ ITALY

BOPP Italia srl

Via Sestriere 5/3
I-10060 Candiolo (TO)
Phone +39 011 9624984
E-mail info@bopp-italia.it
www.bopp.com

■ SWEDEN

BOPP Utildi AB

Box 118
SE-312 22 Laholm
Phone +46 430 792 50
E-mail bopputildi@bopputildi.se
www.bopputildi.se

■ USA

G. BOPP USA Inc.

4 Bill Horton Way
Wappingers Falls, NY 12590
Phone +1 845 296 1065
E-mail info@bopp.com
www.bopp.com

■ KOREA

Samwoo Enterprise (G. BOPP ASIA)

Room 536, Shinan Metro Khan B/D
1115, Bisan-Dong, Dongan-Gu
Anyang-City, Kyungki-Do
Phone +82 31 388 0656
E-mail boppasia@bopp.com

■ CHINA

Samwoo Enterprise (G. BOPP ASIA)

Room 508, Building B
Lotus Square
No. 1050, Wuzhong Road, Minhang
District Shanghai
Phone +86 21 6126-5496 / 5497
E-mail boppasia@bopp.com